

DIRIS A-20

Power Monitoring Device - PMD

measurement and monitoring - door mounting



DIRIS A-20

diris_061_fronteps

The solution for

- > Healthcare
- > Energy
- > Industry



Strong points

- > Easy to use
- > Compliant with standard IEC 61557-12
- > Detects wiring errors
- > Customisable

Conformity to standards

- > IEC 61557-12
- > IEC 62053-22 Class 0.5S
- > IEC 62053-23 class 2
- > UL



Associated software

- > To use Socomec PMDs effectively, we can offer you several dedicated software tools. See "Easy Config System" pages.

Function

DIRIS A-20 units are Power Metering and Monitoring Devices (PMD) that provide the user with all of the measurements needed to complete energy efficient projects successfully and to provide assured monitoring of electrical distribution.

All of this information can be used and analysed remotely using energy efficiency software packages.

Advantages

User-friendly operation

Thanks to its large backlit multi-screen display with 4 hotkeys, the DIRIS A-20 is easy to use.

Compliant with IEC 61557-12

Reference standard for PMDs (Power metering & monitoring devices), Standard IEC 61557-12 guarantees performance levels and satisfactory performance from the PMDs under the environmental conditions typical of industrial and tertiary applications.

Detects wiring errors

The DIRIS A-20 has an error correction function for CT connections.

Customisable

Additional communication and input/output modules can extend the basic functional scope of this product. Equipped with additional modules, the DIRIS A-20 can provide the user with flexibility and expandability throughout the service life of the product.

Functional diagram

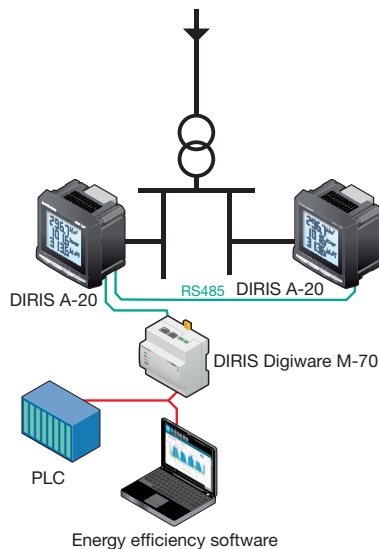

DIRIS_576_L1_fr_cat

Functions

Multi-measurement

- Currents
 - instantaneous: I1, I2, I3, In
 - maximum average: I1, I2, I3, In
- Voltages & frequency
 - instantaneous: V1, V2, V3, U12, U23, U31, F
- Power
 - instantaneous: 3P, ΣP, 3Q, ΣQ, 3S, ΣS
 - maximum average: ΣP, ΣQ, ΣS
- Power factors
 - instantaneous: 3PF, ΣPF

Metering

- Active energy: +/- kWh
- Reactive energy: +/- kVarh
- Hours: ⌚

Harmonic analysis

- Total Harmonic Distortion (up to 51st)
 - Currents: thd I1, thd I2, thd I3
 - Phase-to-neutral voltage: thd V1, thd V2, thd V3
 - Phase-to-phase voltage: thd U12, thd U23, thd U31

Events

Alarms on all electrical parameters

Communications⁽¹⁾

RS485 with MODBUS protocol

Output

- Equipment control
- Alarm report
- Pulse report

Input

- Information report from an external dry contact

(1) Available as an option (see the following pages).

Front panel

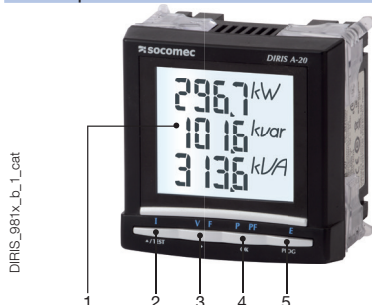

1. Backlit LCD display
2. Pushbutton for currents (instantaneous and maximum), currents THD and the connection correction function.
3. Pushbutton for voltages, frequency and voltages THD.
4. Pushbutton for power (instantaneous and maximum), and active, reactive and effective power factor.
5. Pushbutton for energy sources and time meters.

Case

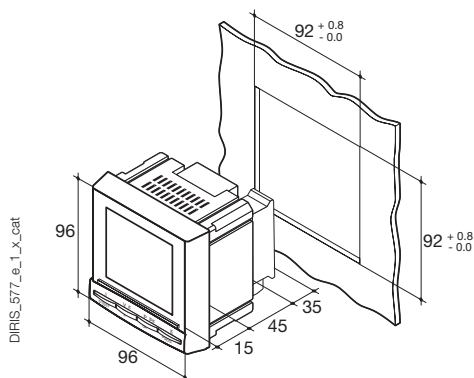

Type	Plug-in
Dimensions W x H x D	96 x 96 x 60 mm
Case Ingress Protection rating	IP30
Front panel Ingress Protection rating	IP52
Display type	Backlit LCD
Terminal blocks type	Fixed or removable
Cross-section for voltage connections and other terminals	0.2 ... 2.5 mm ²
Cross-section for current connections	0.5 ... 6 mm ²
Weight	400 g

Optional snap-on modules

DIRIS® A-20

1 output

1 input that can be configured for:

- pulses: configurable (type, weight, duration) to kWh or kVAh.
- Monitoring: 3I, In, 3V, 3U, F, ΣP, ΣQ, ΣS, ΣPFL/C, THD 3I, THD 3V, THD 3U and time meter.
- Equipment control

Communication

RS485 link with MODBUS protocol (transmission speed up to 38 400 bauds)

3 inputs , 1 output

3 inputs that can be configured into:

- Information report from an external dry contact

1 input that can be configured for:

- pulses: configurable (type, weight, duration) to kWh or kVAh.
- Monitoring: 3I, In, 3V, 3U, F, ΣP, ΣQ, ΣS, ΣPFL/C, THD 3I, THD 3V, THD 3U and time meter.
- Equipment control

Accessories

Current transformer

See "Current transformers" pages.

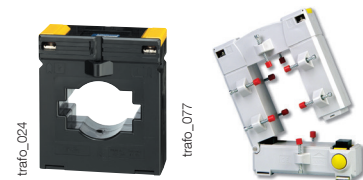

IP65 rating



DIRIS A-20

Power Monitoring Device - PMD

measurement and monitoring - door mounting

Electrical characteristics

Current measurement (TRMS)	
Via CT primary	9999 A
Via CT secondary	5 A
Measurement range	0 ... 11 kA
Input consumption	0.6 VA
Measurement updating period	1 s
Accuracy	0.2%
Permanent overload	6 A
Transient overload	10 I _n over 1 s
Voltage measurements (TRMS)	
Direct measurement between phases	50 ... 500 V AC
Direct measurement between phase and neutral	28 ... 289 VAC
Input consumption	≤ 0.1 VA
Measurement updating period	1 s
Accuracy	0.2%
Power measurement	
Measurement updating period	1 s
Accuracy	0.5%
Power factor measurement	
Measurement updating period	1 s
Accuracy	0.5%
Frequency measurement	
Measurement range	45 ... 65 Hz
Measurement updating period	1 s
Accuracy	0.1%

Energy measurement accuracy	
Active (according to IEC 62053-22)	Class 0.5s
Reactive (according to IEC 62053-23)	Class 2
Auxiliary power supply	
AC voltage	110 ... 400 V AC
AC tolerance	±10%
DC voltage	120 ... 289 VDC
DC tolerance	±20%
Frequency	50 / 60 Hz
Power consumption	10 VA
Pulse or alarm output	
Number	1
Type	100 VDC - 0.5 A - 10 VA
Max number of operations	≤ 10 ⁸
Inputs	
Number	3
Power supply	10 ... 30 VDC
Minimum width of signal	10 ms
Minimum length between 2 pulses	18 ms
Type	Optocouplers
Communication	
Link	RS485
Type	2 to 3 half duplex wires
Protocol	MODBUS [®] RTU
MODBUS [®] speed	1400 ... 38400 bauds
Environment	
Operating temperature range	-10 ... +55 °C
Storage temperature	-20 ... +85 °C
Relative humidity	95%

Terminals

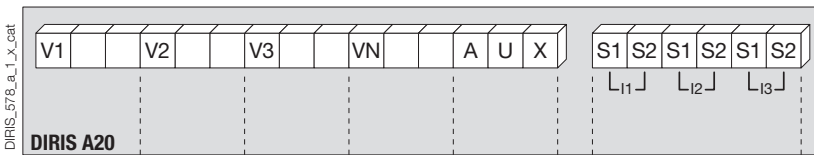

S1 - S2: current inputs.

AUX: auxiliary power supply U_s.
V1, V2, V3 & VN: voltage inputs.

Module communication

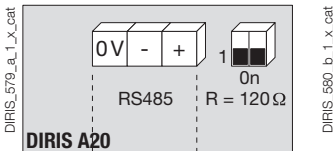

RS485 link.
R = 120 Ω: internal resistance for the RS485 link.

Output or alarm module

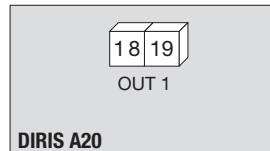

18 - 19: output n°1

Module with 3 inputs, 1 output

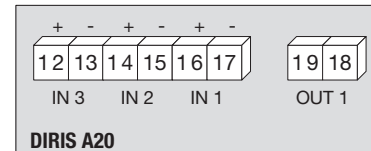

Connection

Low voltage balanced network

Recommendations

- For IT earthing systems, it is recommended that the CT secondary is not connected to earth.
- When disconnecting the DIRIS, the secondary of each current transformer must be short-circuited. This operation can be carried out automatically by a SOCOMEC PTI, which can be found in the SOCOMEC catalogue: please consult us.

3/4 wires with 1 CT

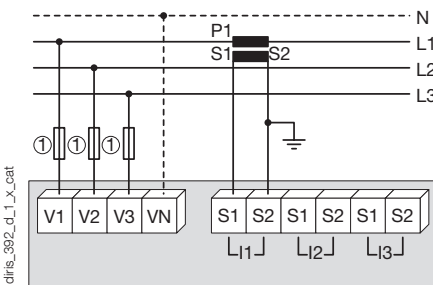

Use of 1 CT reduces by 0.5% the accuracy of the phases for which the current is deduced by vector calculation.
1. 0.5 A gG / 0.5 A class CC fuses.

Single-phase

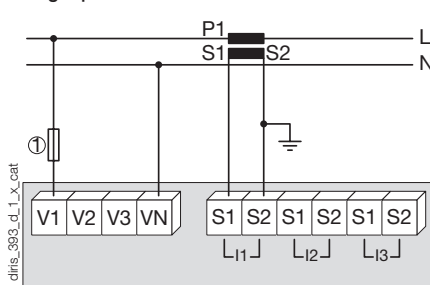

1. 0.5 A gG / 0.5 A class CC fuses.

Two-phase

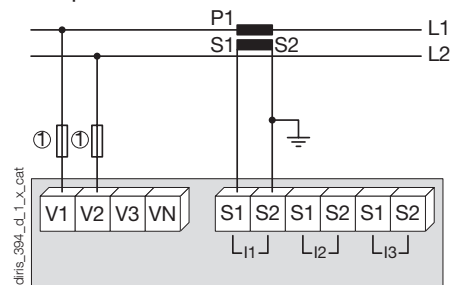

1. 0.5 A gG / 0.5 A class CC fuses.

Low voltage unbalanced network

3/4 wires with 3 CTs

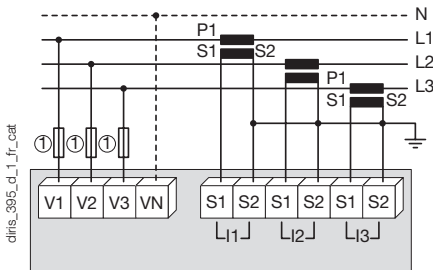

1. 0.5 A gG / 0.5 A class CC fuses.

3 wires with 2 CTs

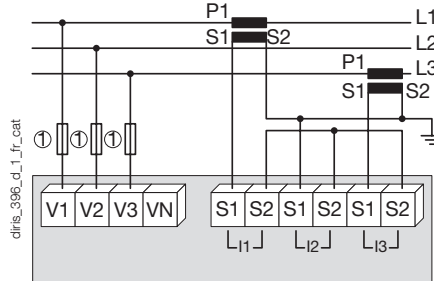

Use of 2 CTs reduces the accuracy by 0.5% for the phase for which the current is deduced by a vector calculation.

1. 0.5 A gG / 0.5 A class CC fuses.

3 wires with 2 CTs

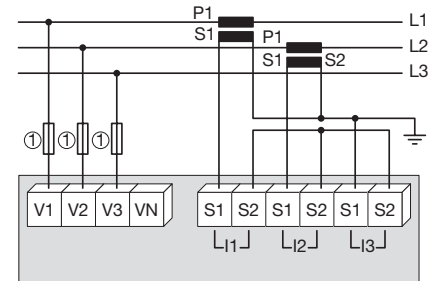

Use of 2 CTs reduces the accuracy by 0.5% for the phase for which the current is deduced by a vector calculation.

1. 0.5 A gG / 0.5 A class CC fuses.

Additional information

Communication via RS485 link

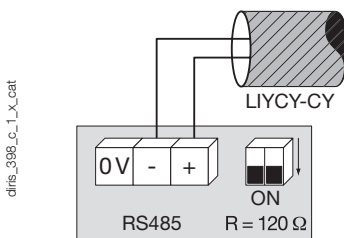

AC and DC auxiliary power supply

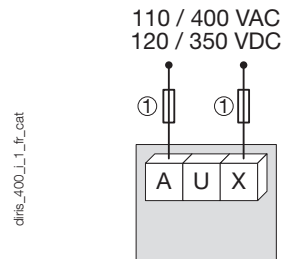

1. 0.5 A gG / 0.5 A class CC fuses.

References

Basic device		DIRIS A-20
Auxiliary power supply U_s		Reference
110 ... 400 VAC / 120 ... 350 VDC		4825 0402
Options		
Plug-in modules.		Reference
On/Off output		4825 0080
RS485 MODBUS® communication		4825 0082
3 inputs , 1 output		4825 0083
Accessories	Available for order in multiples of	Reference
IP65 rating	1	4825 0089
Flush-mounting kit for cutout 144 x 96 mm	1	4825 0088
3-pole fused disconnect switches to protect input voltages (RM type)	4	5601 0018
1-pole + neutral fused disconnect switches to protect the auxiliary supply (RM type)	6	5601 0017
0.5 A 10x38 gG fuses	10	6012 0000
Ferrite for use with communication modules	1	4899 0011
Current transformer range	1	See "TE sensors" pages
Software associated with DIRIS		See "Easy Config System" pages
Automatic CT short-circuiting device		See "Current transformers" pages

Expert Services

- Study, definition , advice, implementation , maintenance and training ... Our "Expert Services" experts offer complete support for the success of your project.

